

Cable Gland Selection Guide

» *Always for your safety*



Always for your safety



RoHS

COMPANY INTRODUCTION

Zhejiang ETEK Electric Technology Co., Ltd. (Abbreviation: ETEK Electric) is a professional manufacturing company dedicated to the research, development, production and sales of low-voltage electrical appliances. The company was established in 2011 and is located in Wenzhou City, Zhejiang Province. At present, the company has a modern factory building of more than 12,000 m². ETEK Electric focuses on the low-voltage electrical fieldwide and has advanced production management systems and production processes. Its products cover electrical safety products for household, commercial, industrial and similar facilities, such as Miniature Circuit Breakers (MCB), Residual Current Devices (RCD), Isolating Switches, Molded Case Circuit Breakers (MCCB), Distribution Board, AC Contactors, Surge Protectors (SPD), IoT Smart Circuit Breakers and Electric Vehicle Charging Facilities (EV Charger), etc.

Relying on hard work and innovation, ETEK Electric's products quickly stand out in the fiercely competitive electrical market. With its own brand 'ETEK', it has successfully entered the international market and signed overseas brand agency contracts with customers from many countries and regions. Its products are exported to the Europe, South America, Middle East, Africa, South Asia and other more than 60 countries and regions.

ETEK Electric always insists on providing customers with safe and reliable electrical products. The company has obtained ISO9001 quality system and RoHS environmental management system certification, and most of its products have also obtained CE, CB, TUV, UKCA, SEMKO, VDE, SAA and other certifications.

ETEK Electric is committed to solving the pressure and challenges of customers and creating value for customers. ETEK Electric has rich industry experience and a dynamic, professional and efficient team, we can provide customers with the best OEM, ODM services.

Growth, Efficiency, Innovation and Quality are ETEK's business goals. We are firmly committed to the field of low voltage electrical products which is your trusted partner.

We hope our products can guarantee the power safety of global users and promote the development of green energy.



WORKSHOPS

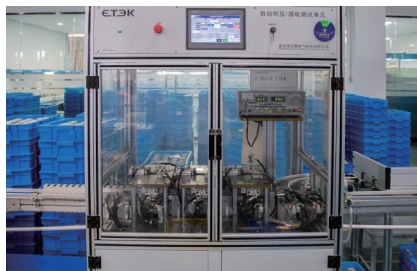

TESTING CENTER

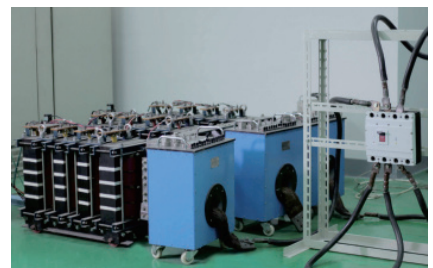

CONTENTS

Nylon Waterproof Cable Gland PG Type	01
Nylon Waterproof Cable Gland Metric Type	02
Nylon Waterproof Cable Long Thread PG Type	03
Nylon Waterproof Cable Gland Long Thread Metric Type	04
Nylon Waterproof Cable Gland G/NPT Type	05
Nylon Waterproof Cable Gland PG Type(Flange Type Cap and Locknut)	06
Nylon Waterproof Cable Gland Metric Type(Flange Type Cap and Locknut)	07
Nylon Waterproof Cable Gland MG Type(Split Type)	08
Nylon Spiral Cable Gland PG/Metric Type	09
Nylon Spiral Cable Gland Long Thread PG/Metric Type	10
Nylon Sprial Cable Gland G/NPT Type	11
Nylon Round Waterproof Screw Plug PG/Metric Type	12
Brass Waterproof Cable Gland PG Type(Long Claw Type)	14
Brass Waterproof Cable Gland Metric Type(Long Claw Type)	15
Brass Waterproof Cable Gland PG Type(Short Claw Type)	16
Brass Waterproof Cable Gland Metric Type(Short Claw Type)	17
Brass Waterproof Cable Gland G/NPT Type	18
Brass Spiral Cable Gland PG/Metric Type	19
Brass Waterproof Screw Plug PG/Metric Type(Round or Hexagon)	20
Brass Adapter	21
Screw Type Wire Connector/Safe Type Wire Connector	23
Cable Buckle Clip/Buckle Wire Protection	24

ETAK

NYLON WATERPROOF CABLE GLAND



Product Description



- **Thread:** German (PG)
- **Materials:** Part A.C.F is made of UL approved nylon PA66 (fire rating UL94V-2), part B.D butadiene rubber (NBR) or EPDM
- **Protection Degree:** IP68 (within fastening range, 0 Type was her will be used in tightening part)
- **Working Temperature:** -40 °C to 100 °C in static state, instantaneous heat resistance up to 120 °C ; -20 °C to 80 °C in dynamic state, instantaneous heat resistance up to 100 °C
- **Product Features:** Wide range for fastening cables, strong tensile strength, waterproof, dustproof, resistant to a cid and alkali, alcohol, grease and general solvents
- **Color:** Light grey (RAL7035), black (RAL9005), other color can be customized according to request

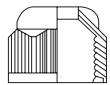

F
Sealing Nut



D
Seal

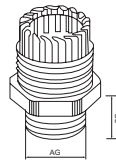

C
Body

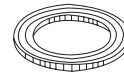

B
Washer

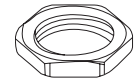

A
Lock Nut

Model	Cable Range(mm) \times	Thread O.D. AG(mm)	Thread Length GL(mm)	Spanner Size(mm) $\frac{\text{H}}{\text{H}}$
PG7	3-6.5	12.5	8	18/17
PG7	2-5			
PG9	4-8	15.2	9	22/19
PG9	2-6			
PG11	5-10	18.6	9.5	24/22
PG11	4-8			
PG13.5	6-12	20.4	10	27/24
PG13.5	5-9			
PG16	10-14	22.5	10	30/27
PG16	8-12			
PG19	12-15	24	10	30/27
PG19	10-14			
PG21	13-18	28.3	10	36/33
PG21	10-16			
PG25	16-20	30	11	37/34
PG25	13-18			
PG29	18-25	37	12	46/42
PG29	13-20			
PG36	22-32	47	14	58/52
PG36	20-26			
PG42	32-38	54	14	64/60
PG42	25-31			
PG48	37-44	59.3	14.5	70/64
PG48	29-35			
PG63	42-50	71	28	82/77
PG63	32-40			

Product Description

- **Thread:** Metric
- **Materials:** Part A.C.F is made of UL approved nylon PA66 (fire rating UL94V-2), part B.D butadiene rubber (NBR) or EPDM
- **Protection Degree:** IP68 (within fastening range, 0 Type was her will be used in tightening part)
- **Working Temperature:** -40 °C to 100 °C in static state, instantaneous heat resistance up to 120 °C ; -20 °C to 80 °C in dynamic state, instantaneous heat resistance up to 100 °C
- **Product Features:** Wide range for fastening cables, strong tensile strength, waterproof, dustproof, resistant to acid and alkali, alcohol, grease and general solvents
- **Color:** Light grey (RAL7035), black (RAL9005), other color can be customized according to request

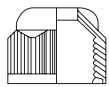

F
Sealing Nut



D
Seal

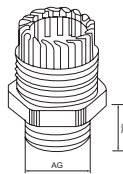

C
Body

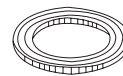

B
Washer

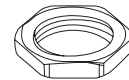

A
Lock Nut

Model	Cable Range(mm) $\frac{1}{2}$	Thread O.D. AG(mm)	Thread Length GL(mm)	Spanner Size(mm) $\frac{1}{2}$
M12x1.5	3-6.5	12	8	18/17
M12x1.5	2-5			18/19
M12x1.5	4-8			22/19
M16x1.5	4-8	16	9	22/22
M16x1.5	2-6			24/22
M16x1.5	5-10	18	10	27/24
M18x1.5	5-10			27/27
M18x1.5	4-8	24	11	30/27
M20x1.5	6-12			33/33
M20x1.5	5-9			36/33
M20x1.5	10-14	22	13	37/34
M22x1.5	10-14			40/35
M22x1.5	8-12	36	12	40/42
M24x1.5	12-15			46/42
M24x1.5	10-14	40	15	50/52
M25x1.5	13-18			62/60
M25x1.5	10-16	50	15	75/68
M27x1.5	13-18			63
M27x1.5	10-16	63	15	
M30x1.5	16-20			
M30x1.5	13-18	32	13	
M32x1.5	16-20			
M32x1.5	13-18	36	12	
M32x1.5	18-25			
M36x1.5	18-25	40	15	
M36x1.5	13-20			
M40x1.5	22-31	50	15	
M40x1.5	20-26			
M50x1.5	32-38	63	15	
M50x1.5	25-31			
M63x1.5	37-44	63	15	
M63x1.5	29-35			

Long Thread PG

Nylon Waterproof Cable Gland

Product Description

- **Thread:** German (PG)
- **Materials:** Part A.C.F is made of UL approved nylon PA66 (fire rating UL94V-2), part B.D butadiene rubber (NBR) or EPDM
- **Protection Degree:** IP68 (within fastening range, 0 Type was her will be used in tightening part)
- **Working Temperature:** -40 °C to 100 °C in static state, instantaneous heat resistance up to 120 °C ; -20 °C to 80 °C in dynamic state, instantaneous heat resistance up to 100 °C
- **Product Features:** Wide range for fastening cables, strong tensile strength, waterproof, dustproof, resistant to acid and alkali, alcohol, grease and general solvents
- **Color:** Light grey (RAL7035), black (RAL9005), other color can be customized according to request

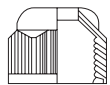

F
Sealing Nut



D
Seal

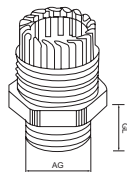

C
Body

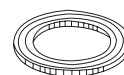

B
Washer

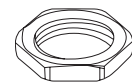

A
Lock Nut

Model	Cable Range(mm) $\varnothing \times \varnothing$	Thread O.D. AG(mm)	Thread Length GL(mm)	Spanner Size(mm) \varnothing
PG7	3-6.5	12.5	15	18/17
PG7	2-5			
PG9	4-8	15.2		
PG9	2-6			
PG11	5-10	18.6		
PG11	4-8			
PG13.5	6-12	20.4		
PG13.5	5-9			
PG16	10-14	22.5		
PG16	8-12			
PG19	12-15	24		
PG19	10-14			
PG21	13-18	28.3		
PG21	16-16			
PG25	16-20	30		
PG25	13-18			
PG29	18-25	37	18	46/42
PG29	13-20			
PG36	22-32	47		
PG36	20-26			
PG42	32-38	54		
PG42	25-31			
PG48	37-44	59.3		
PG48	29-35			
PG63	42-50	71		28
PG63	32-40			

Product Description

- **Thread:** Metric
- **Materials:** Part A.C.F is made of UL approved nylon PA66 (fire rating UL94V-2), part B.D butadiene rubber (NBR) or EPDM
- **Protection Degree:** IP68 (within fastening range, O Type was here will be used in tightening part)
- **Working Temperature:** -40 °C to 100 °C in static state, instantaneous heat resistance up to 120 °C ; -20 °C to 80 °C in dynamic state, instantaneous heat resistance up to 100 °C
- **Product Features:** Wide range for fastening cables, strong tensile strength, waterproof, dustproof, resistant to acid and alkali, alcohol, grease and general solvents
- **Color:** Light grey (RAL7035), black (RAL9005), other color can be customized according to request

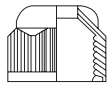

F
Sealing Nut



D
Seal

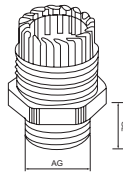

C
Body

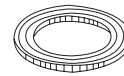

B
Washer

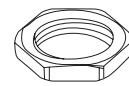

A
Lock Nut

Model	Cable Range (mm) ϕ	Thread O.D. AG (mm)	Thread Length GL (mm)	Spanner Size (mm) ϕ	
M12x1.5	3-6.5	12	15	18/17	
M12x1.5	2-5			18/19	
M12x1.5	4-8			22/19	
M16x1.5	4-8	16		22/22	
M16x1.5	2-6			24/22	
M16x1.5	5-10	18		18	27/24
M18x1.5	5-10				27/27
M18x1.5	4-8	20			30/27
M20x1.5	6-12				22
M20x1.5	5-9	24			
M20x1.5	10-14				25
M22x1.5	10-14	27			
M22x1.5	8-12		30		40/42
M24x1.5	12-15	32			
M24x1.5	10-14		36		50/52
M25x1.5	13-18	40			
M25x1.5	10-16		50		75/68
M27x1.5	13-18	63			
M27x1.5	10-16				
M30x1.5	16-20				
M30x1.5	13-18				
M32x1.5	16-20				
M32x1.5	13-18				
M32x1.5	18-25				
M36x1.5	18-25				
M36x1.5	13-20				
M40x1.5	22-31				
M40x1.5	20-26				
M50x1.5	32-38				
M50x1.5	25-31				
M63x1.5	37-44				
M63x1.5	29-35				

Product Description

- **Thread:** British(g) / American(NPT)
- **Materials:** Part A.C.F is made of UL approved nylon PA66(fire rating UL94V-2), part B.D butadiene rubber (NBR) or EPDM
- **Protection Degree:** IP68(within fastening range, 0 Type was her will be used in tightening part)
- **Working Temperature:** -40 °C to 100 °C in static state, instantaneous heat resistance up to 120 °C ; -20 °C to 80 °C in dynamic state, instantaneous heat resistance up to 100°C
- **Product Features:** Wide range for fastening cables, strong tensile strength, waterproof, dustproof, resistant to a cid and alkali, alcohol, grease and general solvents
- **Color:** Light grey(RAL7035), black(RAL9005), other color can be customized according to request

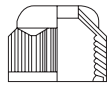

F
Sealing Nut



D
Seal

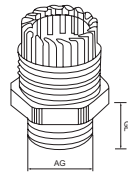

C
Body

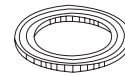

B
Washer

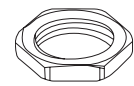

A
Lock Nut

Model	Cable Range(mm) \varnothing	Thread O.D. AG(mm)	Thread Length GL(mm)	Spanner Size(mm) \varnothing
G1/4	3-6.5	13.1	8.5	19/17
G1/4	2-5			19/19
G1/4	4-8			24/19
G3/8	4-8	16.6	15	24/22
G3/8	5-10			27/24
G1/2	6-12	20.9	13	27/27
G1/2	10-14			33/33
G3/4	13-18	26.4	15	40/42
G1	18-25	33.2	16	50/46
G11/4	18-25	41.9	18	46/51
G11/4	22-31		14	58/52
G11/2	22-31	47.8	15	58/60
G11/2	32-38		18	70/68
G2	37-44	59.6	15.5	

Model	Cable Range(mm) \varnothing	Thread O.D. AG(mm)	Thread Length GL(mm)	Spanner Size(mm) \varnothing
NPT1/4	3-6.5	13.7	8.5	19/17
NPT1/4	2-5			19/19
NPT1/4	4-8			24/19
NPT3/8	4-8	17.1	15	24/22
NPT3/8	5-10			27/24
NPT1/2	6-12	21.3	13	27/27
NPT1/2	10-14			33/33
NPT3/4	13-18	26.6	15	40/42
NPT1	18-25	33.3	16	50/46
NPT11/4	18-25	42	18	46/51
NPT11/4	22-31		14	58/52
NPT11/2	22-31	48	15	58/60
NPT11/2	32-38		18	70/68
NPT2	37-44	60	15.5	

Product Description



- **Thread:** German(PG)
- **Materials:** Part A.C.F is made of UL approved nylon PA66(fire rating UL94V-2), part B.D butadiene rubber (NBR) or EPDM
- **Protection Degree:** IP68(within fastening range, 0 Type was her will be used in tightening part)
- **Working Temperature:** -40 °C to 100 °C in static state, instantaneous heat resistance up to 120 °C ; -20 °C to 80 °C in dynamic state, instantaneous heat resistance up to 100°C
- **Product Features:** Wide range for fastening cables, strong tensile strength, waterproof, dustproof, resistant to acid and alkali, alcohol, grease and general solvents
- **Color:** Light grey(RAL7035), black(RAL9005), other color can be customized according to request

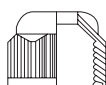

F
Sealing Nut

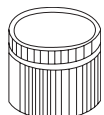

D
Seal

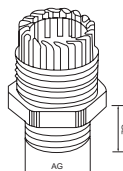

C
Body



B
Washer



A
Lock Nut

Model	Cable Range(mm) ϕ	Thread O.D. AG(mm)	Thread Length GL(mm)	Spanner Size(mm) ϕ
PG 7S	3-6.5	12.5	8	17/15
PG 7	4-8		8	17/19
PG 9			15.2	8
PG 11	5-10	18.6	10	24/22
PG 13.5	6-12	20.4	10	27/24
PG 16	10-14	22.5	10.8	30/27
PG 19	12-16	24	11	
PG 21	13-18	28.3	12	36/33
PG 25	14-20	30	12	37/36
PG 29	18-25	37	12	46/42
PG 36	24-32	47	15	58/52
PG 42	32-38	54	15	64/62
PG 48	37-44	59.3	18	70/65

Product Description

- **Thread:** Metric
- **Materials:** Part A.C.F is made of UL approved nylon PA66 (fire rating UL94V-2), part B.D butadiene rubber (NBR) or EPDM
- **Protection Degree:** IP68 (within fastening range, 0 Type was her will be used in tightening part)
- **Working Temperature:** -40 °C to 100 °C in static state, instantaneous heat resistance up to 120 °C ; -20 °C to 80 °C in dynamic state, instantaneous heat resistance up to 100 °C
- **Product Features:** Wide range for fastening cables, strong tensile strength, waterproof, dustproof, resistant to acid and alkali, alcohol, grease and general solvents
- **Color:** Light grey (RAL7035), black (RAL9005), other color can be customized according to request

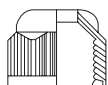

F
Sealing Nut

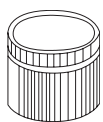

D
Seal

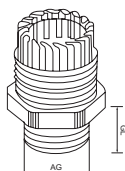

C
Body

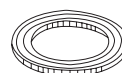

B
Washer

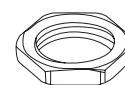

A
Lock Nut

Model	Cable Range(mm) \varnothing	Thread O.D. AG(mm)	Thread Length GL(mm)	Spanner Size(mm) \varnothing
M10x1.5	2-3.5	10	8	13/13
M12x1.5S	3-6.5	12	8.5	17/15
M12x1.5	4-8			17/19
M16x1.5S	5-10	16	10	22/19
M16x1.5				22/22
M18x1.5S				24/22
M18x1.5	6-12	18		24/24
M20x1.5S	10-14	20	11	27/24
M20x1.5				27/27
M22x1.5				
M24x1.5	12-16	24		30/27
M25x1.5S	13-18	25	12	33/27
M25x1.5				33/33
M32x1.5S				37/36
M32x1.5	18-25	32		37/42
M36x1.5		36		45/42
M40x1.5	23-32	40	15	50/52
M50x1.5	30-38	50		62/62
M63x1.5	35-45	63	18	75/68

Product Description



- **Thread:** Metric
- **Materials:** Part A.C.E.F is made of UL approved nylon PA66(fire rating UL94V-2), part B.D butadiene rubber (NBR) or EPDM
- **Protection Degree:** IP68(within fastening range, 0 Type was her will be used in tightening part)
- **Working Temperature:** -40 °C to 100 °C in static state, instantaneous heat resistance up to 120 °C ; -20 °C to 80 °C in dynamic state, instantaneous heat resistance up to 100°C
- **Product Features:** Wide range for fastening cables, strong tensile strength, waterproof, dustproof, resistant to acid and alkali, alcohol, grease and general solvents
- **Color:** Light grey(RAL7035), black(RAL9005), other color can be customized according to request

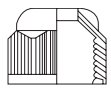

F
Sealing Nut

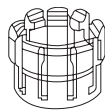

E
Claw



D
Seal

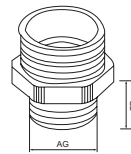

C
Body

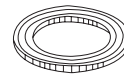

B
Washer



A
Lock Nut

Model	Cable Range(mm) \times	Thread O.D. AG(mm)	Thread Length GL(mm)	Spanner Size(mm) ϕ
MG-12A	4.5-8	12	8.5	17/19
MG-12A	3-5.3			
MG-16A	6-10	16	15	22/22
MG-16A	4-8			
MG-20A	10-14	20	15	27/27
MG-20A	6-12			
MG-25A	13-18	25	15	33/33
MG-25A	10-16			
MG-32A	18-25	32	15	41/41
MG-32A	15-22			
MG-40A	24-30	40	20	50/50
MG-40A	20-25			
MG-50A	30-40	50	23	61/62
MG-50A	26-32			
MG-63A	40-50	63	24.5	74/76
MG-63A	38-46			

Product Description



- **Thread:** German(PG) / Metric
- **Materials:** Part A.C.F is made of UL approved nylon PA66(fire rating UL94V-2), part B.D butadiene rubber (NBR) or EPDM
- **Protection Degree:** IP68(within fastening range, 0 Type was her will be used in tightening part)
- **Working Temperature:** -40 °C to 100 °C in static state, instantaneous heat resistance up to 120 °C ; -20 °C to 80 °C in dynamic state, instantaneous heat resistance up to 100°C
- **Product Features:** Wide range for fastening cables, strong tensile strength, waterproof, dustproof, resistant to a cid and alkali, alcohol, grease and general solvents
- **Color:** Light grey(RAL7035), black(RAL9005), other color can be customized according to request



F Sealing Nut



D Seal

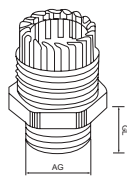

C Body



B Washer



A Lock Nut

Model	Cable Range(mm) ∇ ∇	Thread O.D. AG(mm)	Thread Length GL(mm)	Spanner Size(mm) ∇
PG7	3-6.5	12.5	8	18/17
PG7	2-5			
PG9	4-8	15.2	9	22/19
PG9	2-6			
PG11	5-10	18.6	9.5	24/22
PG11	4-8			
PG13.5	6-12	20.4	10	27/24
PG13.5	5-9			
PG16	10-14	22.5		30/27
PG16	8-12			
PG21	13-18	28.3	36/33	
PG21	10-16			

Model	Cable Range(mm) ∇ ∇	Thread O.D. AG(mm)	Thread Length GL(mm)	Spanner Size(mm) ∇
M12x1.5	3-6.5	12	8	18/17
M12x1.5	2-5			
M12x1.5	4-8	16	9	18/19
M16x1.5				
M16x1.5	2-6	18	22/19	
M16x1.5	5-10			
M18x1.5	4-8	20	9	22/22
M18x1.5	6-12			
M20x1.5	5-9	22	10	24/22
M20x1.5	10-14			
M20x1.5	8-12	25	10	27/24
M22x1.5				
M22x1.5	13-18	27	10	27/27
M22x1.5	10-16			
M25x1.5	13-18	27	10	30/27
M25x1.5	10-16			
M27x1.5	13-18	27	10	33/33
M27x1.5	10-16			

Product Description

- **Thread:** German(PG) / Metric
- **Materials:** Part A.C.F is made of UL approved nylon PA66(fire rating UL94V-2), part B.D butadiene rubber (NBR) or EPDM
- **Protection Degree:** IP68(within fastening range, 0 Type was her will be used in tightening part)
- **Working Temperature:** -40 °C to 100 °C in static state, instantaneous heat resistance up to 120 °C ; -20 °C to 80 °C in dynamic state, instantaneous heat resistance up to 100°C
- **Product Features:** Wide range for fastening cables, strong tensile strength, waterproof, dustproof, resistant to acid and alkali, alcohol, grease and general solvents
- **Color:** Light grey(RAL7035), black(RAL9005), other color can be customized according to request



F
Sealing Nut



D
Seal

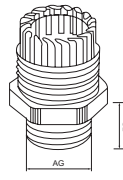

C
Body

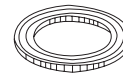

B
Washer

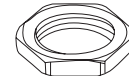

A
Lock Nut

Model	Cable Range(mm) $\sqrt{\times}$	Thread O.D. AG(mm)	Thread Length GL(mm)	Spanner Size(mm) $\sqrt{\text{H}}$
PG7	3-6.5	12.5	15	18/17
PG7	2-5			
PG9	4-8	15.2		
PG9	2-6			
PG11	5-10	18.6		
PG11	4-8			
PG13.5	6-12	20.4		
PG13.5	5-9			
PG16	10-14	22.5		
PG16	8-12			
PG21	13-18	28.3		
PG21	10-16			

Model	Cable Range(mm) $\sqrt{\times}$	Thread O.D. AG(mm)	Thread Length GL(mm)	Spanner Size(mm) $\sqrt{\text{H}}$
M12x1.5	3-6.5	12	15	18/17
M12x1.5	2-5			
M12x1.5	4-8	16		
M16x1.5				
M16x1.5	2-6			
M16x1.5	5-10	18		
M18x1.5				
M18x1.5	4-8			
M20x1.5	6-12	20		
M20x1.5	5-9			
M20x1.5	10-14	22		
M22x1.5	10-14			
M22x1.5	8-12			
M25x1.5	13-18	25		
M25x1.5	10-16			
M27x1.5	13-18	27		
M27x1.5	10-16			

Product Description

- **Thread:** British(G) / American(NPT)
- **Materials:** Part A.C.F is made of UL approved nylon PA66(fire rating UL94V-2), part B.D butadiene rubber (NBR) or EPDM
- **Protection Degree:** IP68(within fastening range, 0 Type was her will be used in tightening part)
- **Working Temperature:** -40 °C to 100 °C in static state, instantaneous heat resistance up to 120 °C ; -20 °C to 80 °C in dynamic state, instantaneous heat resistance up to 100°C
- **Product Features:** Wide range for fastening cables, strong tensile strength, waterproof, dustproof, resistant to a cid and alkali, alcohol, grease and general solvents
- **Color:** Light grey(RAL7035), black(RAL9005), other color can be customized according to request



F
Sealing Nut



D
Seal

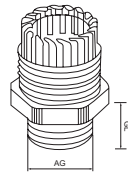

C
Body



B
Washer

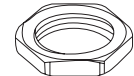

A
Lock Nut

Model	Cable Range(mm) \varnothing	Thread O.D. AG(mm)	Thread Length GL(mm)	Spanner Size(mm) \varnothing
G1/4	3-6.5	13.1	8.5	19/17
G1/4	2-5			
G1/4	4-8			
G3/8	5-10	16.6	15	24/19
G3/8	6-12			24/22
G1/2	10-14	20.9	13	27/24
G1/2	13-18			27/27
G3/4		26.4	15	33/33

Model	Cable Range(mm) \varnothing	Thread O.D. AG(mm)	Thread Length GL(mm)	Spanner Size(mm) \varnothing
NPT1/4	3-6.5	13.7	8.5	19/17
NPT1/4	2-5			
NPT1/4	4-8			
NPT3/8	5-10	17.1	15	24/19
NPT3/8	6-12			24/22
NPT1/2	10-14	21.3	13	27/24
NPT1/2	13-18			27/27
NPT3/4		26.6	15	33/33

Product Description

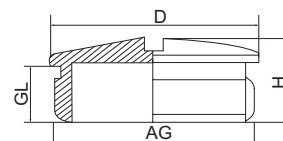

• Nylon round plug

- **Thread:** German(PG) / Metric
- **Materials:** Made of UL approved nylon PA66(fire rating UL94V-2)
- **Working Temperature:** -40°C to 100°C
- **Protection Degree:** IP68(within fastening range, 0 Type was her will be used in tightening part)
- **Color:** Light grey(RAL7035), black(RAL9005), other color can be customized according to request

Model	Thread O.D. AG(mm)	Thread Length GL(mm)	Main Body Dimensions H(mm)	Cover Dimensions D(mm)
PG7	12.5	8.5	12.5	15
PG9	15.2	9	13	19
PG11	18.6			22
PG13.5	20.4			25
PG16	22.5			27
PG19	24	10.5	15.5	29
PG21	28.3			33
PG25	30	11	16	35
PG29	37	12		44
PG36	47	13.5	18	55
PG42	54			62
PG48	59.3	14.5	19	68

Model	Thread O.D. AG(mm)	Thread Length GL(mm)	Main Body Dimensions H(mm)	Cover Dimensions D(mm)
M12x1.5	12	8.5	12.5	15
M16x1.5	16	9	13	19
M18x1.5	18			22
M20x1.5	20			25
M22x1.5	22			27
M24x1.5	24	10.5	15.5	29
M25x1.5	25			30
M27x1.5	27	11	16	33
M30x1.5	30			35
M32x1.5	32			38
M40x1.5	40	11.5	18	46
M50x1.5	50	13.5		56
M63x1.5	63	14	19	68

ETAK

BRASS WATERPROOF CABLE GLAND



Product Description



- **Thread:** German(PG)
- **Materials:** Part A.C.F is made of UL certified nickel plated brass, part E is made of UL approved nylon PA66(fire rating UL94V-2), part B.D butadiene rubber (NBR) or EPDM
- **Protection Degree:** IP68(within fastening range, 0 Type was her will be used in tightening part)
- **Working Temperature:** -40°C to 100°C in static state, instantaneous heat resistance up to 120°C
- **Product Features:** Wide range for fastening cables, strong tensile strength, waterproof, dustproof, resistant to acid and alkali, alcohol, grease and general solvents

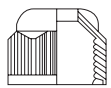

F
Sealing Nut

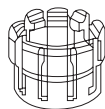

D
Seal



E
Claw

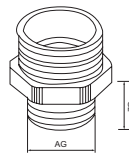

C
Body

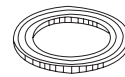

B
Washer

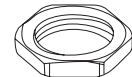

A
Lock Nut

Model	Cable Range(mm) \times	Thread O.D. AG(mm)	Thread Length GL(mm)	Spanner Size(mm) ϕ
PG7	3-6.5	12.5	6	14
PG9	4-8	15.2	7	17
PG11	5-10	18.6	7.5	20
PG13.5	6-12	20.4		22
PG16	10-14	22.5		24
PG19	10-15	24	8	25
PG21	13-18	28.3		30
PG25	15-20	30	9	33
PG29	18-25	37		40
PG36	25-32	47	10	50
PG42	32-38	54	11	57
PG48	37-44	59.3		64

Product Description

- **Thread:** Metric
- **Materials:** Part A.C.F is made of UL certified nickel plated brass, part E is made of UL approved nylon PA66(fire rating UL94V-2), part B.D butadiene rubber (NBR) or EPDM
- **Protection Degree:** IP68(within fastening range, 0 Type was her will be used in tightening part)
- **Working Temperature:** -40°C to 100°C in static state, instantaneous heat resistance up to 120°C
- **Product Features:** Wide range for fastening cables, strong tensile strength, waterproof, dustproof, resistant to a cid and alkali, alcohol, grease and general solvents

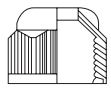

F
Sealing Nut

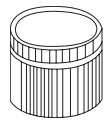

D
Seal

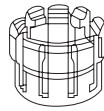

E
Claw

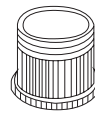

C
Body

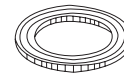

B
Washer

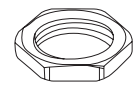

A
Lock Nut

Model	Cable Range(mm) ϕ \times ϕ	Thread O.D. AG(mm)	Thread Length GL(mm)	Spanner Size(mm) ϕ
M12x1.5	3-6.5	12	6	14
M16x1.5	4-8	16	7	17
M18x1.5	5-10	18	7.5	20
M20x1.5	6-12	20		22
M22x1.5	10-14	22	8	24
M24x1.5	10-15	24		26
M25x1.5	12-16	25		27
M27x1.5	13-18	27	9	30
M30x1.5	15-20	30		33
M32x1.5	16-22	32		35
M36x1.5	18-25	36	10	40
M40x1.5	22-30	40		45
M50x1.5	32-38	50	11	57
M63x1.5	37-44	63		68

Product Description



- **Thread:** German(PG)
- **Materials:** Part A.C.F is made of UL certified nickel plated brass, part E is made of UL approved nylon PA66(fire rating UL94V-2), part B.D butadiene rubber (NBR) or EPDM
- **Protection Degree:** IP68(within fastening range, 0 Type was her will be used in tightening part)
- **Working Temperature:** -40°C to 100°C in static state, instantaneous heat resistance up to 120°C
- **Product Features:** Wide range for fastening cables, strong tensile strength, waterproof, dustproof, resistant to acid and alkali, alcohol, grease and general solvents

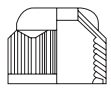

F
Sealing Nut

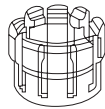

D
Seal



E
Claw

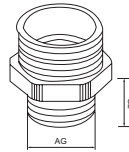

C
Body

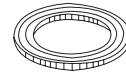

B
Washer



A
Lock Nut

Model	Cable Range(mm) ϕ	Thread O.D. AG(mm)	Thread Length GL(mm)	Spanner Size(mm) ϕ
PG7	3-6.5	12.5	6	14
PG9	4-8	15.2	7	17
PG11	5-10	18.6	7.5	20
PG13.5	6-12	20.4		22
PG16	10-14	22.5		24
PG19	10-15	24	8	25
PG21	13-18	28.3		30
PG25	15-20	30	9	33
PG29	18-25	37		40
PG36	25-32	47	10	50
PG42	32-38	54	11	57
PG48	37-44	59.3		64
PG63	42-52	72	20	78

Product Description

- **Thread:** Metric
- **Materials:** Part A.C.F is made of UL certified nickel plated brass, part E is made of UL approved nylon PA66(fire rating UL94V-2), part B.D butadiene rubber (NBR) or EPDM
- **Protection Degree:** IP68(within fastening range, 0 Type was her will be used in tightening part)
- **Working Temperature:** -40°C to 100°C in static state, instantaneous heat resistance up to 120°C
- **Product Features:** Wide range for fastening cables, strong tensile strength, waterproof, dustproof, resistant to a cid and alkali, alcohol, grease and general solvents

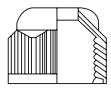

F
Sealing Nut

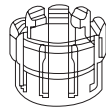

D
Seal

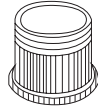

E
Claw

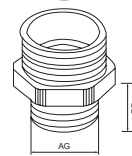

C
Body

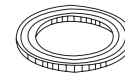

B
Washer

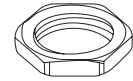

A
Lock Nut

Model	Cable Range(mm) Φ	Thread O.D. AG(mm)	Thread Length GL(mm)	Spanner Size(mm) Φ
M8x1	2-5	8	5	12
M10x1(1.5)	3-6.5	10	6	14
M12x1.5		12		
M14x1.5	4-8	14	7	17
M16x1.5		16		
M18x1.5	5-10	18	7.5	20
M20x1.5	6-12	20		
M22x1.5	10-14	22	8	24
M24x1.5	10-15	24		
M25x1.5	12-16	25	9	26
M25x1.5		27		
M27x1.5(2)	13-18	27	10	30
M28x1.5(2)		28		
M30x1.5(2)	15-20	30	11	33
M32x1.5(2)	16-22	32		
M33x1.5(2)		33		
M36x1.5(2)	18-25	36	20	40
M38x1.5(2)		38		
M40x1.5(2)	22-30	40	11	45
M42x1.5(2)		42		
M48x1.5(2)	22-32	48	10	50
M50x1.5(2)	32-38	50		
M54x1.5(2)		54		
M58x1.5(2)	37-44	58	11	64
M60x1.5(2)		60		
M63x1.5(2)		63		
M64x1.5(2)		64		
M70x2	42-52	70	20	78
M72x2		72		
M75x2		75		
M80x2	55-62	80	11	87
M88x2	62-70	88		
M90x2		90		
M100x2	76-84	100		111

Product Description

- **Thread:** British(g) / American(NPT)
- **Materials:** Part A.C.F is made of UL certified nickel plated brass, part E is made of UL approved nylon PA66(fire rating UL94V-2), part B.D butadiene rubber (NBR) or EPDM
- **Protection Degree:** IP68(within fastening range, 0 Type was her will be used in tightening part)
- **Working Temperature:** -40°C to 100°C in static state, instantaneous heat resistance up to 120°C
- **Product Features:** Wide range for fastening cables, strong tensile strength, waterproof, dustproof, resistant to acid and alkali, alcohol, grease and general solvents

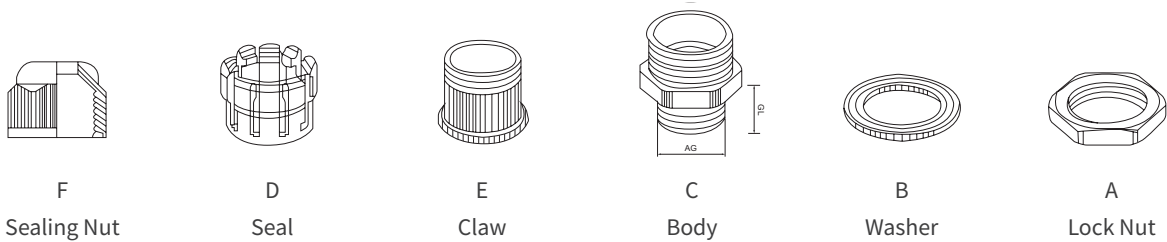

Model	Cable Range(mm) \varnothing	Thread O.D. AG(mm)	Thread Length GL(mm)	Spanner Size(mm) \varnothing
G1/4	3-6.5	13.1	6	16
G3/8	4-8	16.6	7	19
G1/2	6-12	20.9	7.5	24
G3/4	13-18	20.4	8	32
G1	18-25	33.2	9	42
G1 1/4		41.9	10	46
G1 1/2	22-32	47.8	11	52
G1 1/2	32-38			60
G2	37-44	59.6		68

Model	Cable Range(mm) \varnothing	Thread O.D. AG(mm)	Thread Length GL(mm)	Spanner Size(mm) \varnothing
NPT1/4	3-6.5	13.7	6	16
NPT3/8	4-8	17.1	7	19
NPT1/2	6-12	21.2	7.5	24
NPT3/4	13-18	26.6	8	33
NPT1	18-25	33.3	9	42
NPT1 1/4		42	10	46
NPT1 1/2	22-32	48	11	52
NPT1 1/2	32-38			60
NPT2	37-44	60		68

Product Description



- **Thread:** German(PG) / Metric
- **Materials:** Part A.C.F is made of UL certified nickel plated brass, part E is made of UL approved nylon PA66(fire rating UL94V-2), part B.D butadiene rubber (NBR) or EPDM
- **Protection Degree:** IP68(within fastening range, 0 Type was her will be used in tightening part)
- **Working Temperature:** -40°C to 100°C in static state, instantaneous heat resistance up to 120°C
- **Product Features:** Wide range for fastening cables, strong tensile strength, waterproof, dustproof, resistant to acid and alkali, alcohol, grease and general solvents

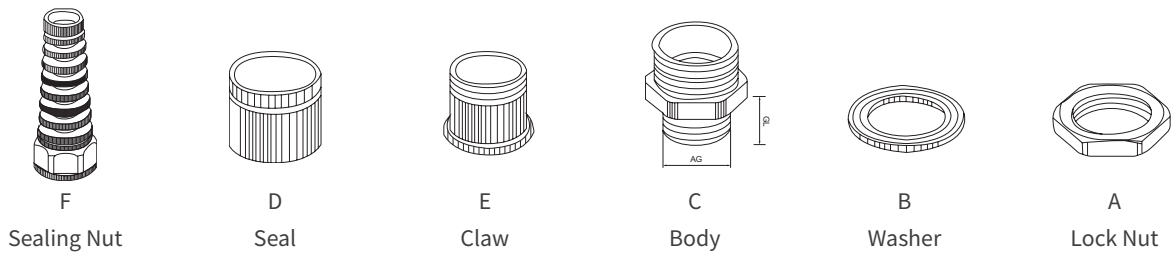

Model	Cable Range(mm) $\sqrt{\times}$	Thread O.D. AG(mm)	Thread Length GL(mm)	Spanner Size(mm) ϕ
PG7	3-6.5	12.5	6	14
PG9	4-8	15.2	7	17
PG11	5-10	18.6	7.5	20
PG13.5	6-12	20.4		22
PG16	10-14	22.5		24
PG21	13-18	28.3	8	30

Model	Cable Range(mm) $\sqrt{\times}$	Thread O.D. AG(mm)	Thread Length GL(mm)	Spanner Size(mm) ϕ
M12x1.5	3-6.5	12	6	14
M16x1.5	4-8	16	7	17
M18x1.5	5-10	18	7.5	20
M20x1.5	6-12	20		22
M22x1.5	10-14	22		24
M25x1.5	13-18	25	8	30
M27x1.5		27		

Product Description

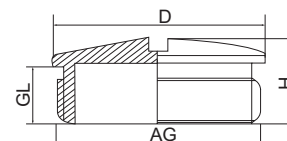

• Round plug

- **Thread:** German(PG) / Metric
- **Materials:** Nickel plated brass
- **Protection Degree:** IP68(within fastening range, 0 Type was her will be used in tightening part)
- **Working Temperature:** -40°C to 100°C

Model	Thread O.D. AG(mm)	Thread Length GL(mm)	Main Body Dimensions H(mm)	Cover Dimensions D(mm)
PG7	12.5	6	9	14
PG9	15.2	7	10.5	17
PG11	18.6			20
PG13.5	20.4	7.5	11	22
PG16	22.5			24
PG19	24	8	11.5	26
PG21	28.3			30
PG25	30	9	12.5	32
PG29	37			40
PG36	47			50
PG42	54	10	17	57
PG48	59.3	11	18	64

Model	Thread O.D. AG(mm)	Thread Length GL(mm)	Main Body Dimensions H(mm)	Cover Dimensions D(mm)
M12x1.5	12	6	9	14
M16x1.5	16	7	10.5	17
M18x1.5	18			20
M20x1.5	20	7.5	11	22
M22x1.5	22			24
M24x1.5	24	8	11.5	26
M25x1.5	25			27
M27x1.5	27			30
M30x1.5	30	9	12.5	32
M32x1.5	32			34
M40x1.5	40			42
M50x1.5	50	10	17	52
M63x1.5	63	11	19	68

Brass Adapter

Product Description

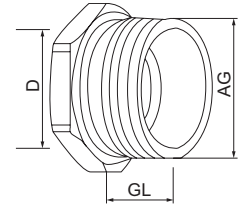

• Brass adapter

- **Thread:** German(PG) / Metric
- **Materials:** Nickel plated brass
- **Protection Degree:** IP68(within fastening range, 0 Type was her will be used in tightening part)
- **Working Temperature:** -40°C to 100°C in static state

Model	Thread O.D AG(mm)	Thread Length D(mm)	Thread Length GL(mm)	Spanner Size(mm) ⌀
M1612	M16x1.5	M12x1.5	6	18
M2016	M20x1.5	M16x1.5	6.5	22
M2520	M25x1.5	M20x1.5	7	30
M3225	M32x1.5	M25x1.5	8	40
M4032	M40x1.5	M32x1.5	9	50
M5040	M50x1.5	M40x1.5	10	59
M6350	M63x1.5	M50x1.5		67

ETAK

WIRE CONNECTOR / WIRE PROTECTION



Screw Type Wire Connector / Safe Type Wire Connector

Product Description

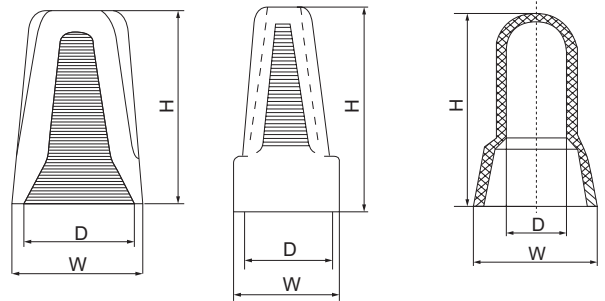

Spring inside
• HS screw crimping cap

• Safety crimping cap

- Thermoplastic engineering plastics shell, flame retardant rating of UL94V-2
- Galvanized carbon steel spring
- Plug in the connector after stripping, rotate the connector and let the spring clamp the wire
- It can used to replace the traditional connection mode of insulating tape
- Applicable for all kinds of electrical products, light fixtures, household wiring and other wiring equipment

Type	Model	Color	H(mm)	W(mm)	Thread I.D. D(mm)	Applied Cable Range
HS screw crimping cap	P1	Grey	15.2	8.6	6.5	22~14
	P2	Blue	17.7	9.9	7.1	
	P3	Orange	22	12.7	9.7	
	P4	Yellow	24.6	14	11	20~10
	P6	Red	26.5	16.3	13.1	22~10
	P6H		26.6	16.3		

Product Description

- PA66 engineering plastics shell, flame retardant rating of UL94V-2
- Copper or aluminum terminal block
- Plug in the terminal after stripping, tighten by tool
- Vibration resistant and firm
- It can used to replace the traditional connection mode of insulating tape
- Applicable for all kinds of electrical products, light fixtures, household wiring and other wiring equipment

Type	Model	H(mm)	W(mm)	Thread I.D. D(mm)	Applied Cable Range	
					Square Line mm ²	A.W.G
Safety crimping cap	CE-1	18	7.8	2.6	1.25	22~18
	CE-2	20	9.5	3.1	2	22~14
	CE-5	25.5	12.5	4.4	5.5	22~10
	CE-8	27.7	14.3	5.3	8	16~10

Product Description

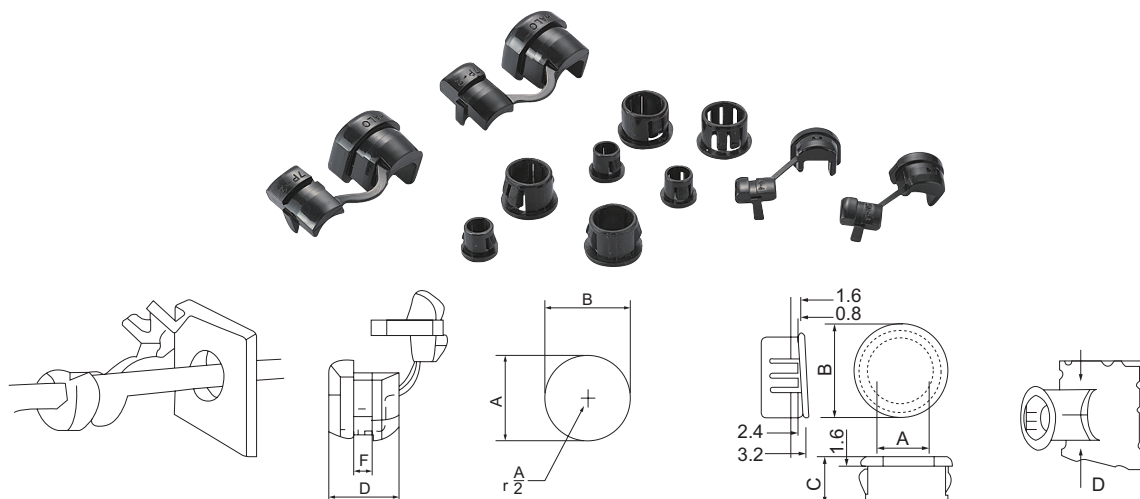

• Power cord buckle

• Buckles type line protective cover

- PA66 engineering plastics shell, flame retardant rating of UL94V-2
- Operating temperature should not exceed 75°C (167° F)
- Power line can be fixed to prevent from sliding and being scratched
- Set the power line in the wire buckle and use tool to place it in the outlet hole of machine board and then fix it
- Applicable for all kinds of electrical products, light fixtures and other power line outlet holes

Model	Shape	Applied UL wire(mm)	Applied cable dimension(mm)	Machine Plate Caliber		Applied Machine Plate Thickness F(mm)	Line Buckle Length D(mm)
				A(mm)	B(mm)		
2P-4	Flat	SPT-1	3x5.6	9.5	8.7	1.6	10.3
3P-4				11	9.9	2.5	
3W-1						1.6	
4N-4						2.5	
4K-4				SPT-2	3.71/3.8x7.6	12.7-13.1	
5N-4	2.5						
5P-4	Round	SVI SVT	6.4Φ-7.4Φ	15.9	11.5	1.6	11
6N-4						2.5	
6P-4		SJT 3C#18	7.6Φ	15.9	14	1.6	14.8
6N3-4						3.2	
6P3-4		SJT 3C#16	8.2Φ-9.2Φ	19-19.8	16.8	1.6	19
7N-2						3.2	
7P-2		SJT 3C#14	9.2Φ-10.5Φ-11Φ	19-19.8	16.8	1.6	
						3.2	

Product Description

- PA66 engineering plastics shell, flame retardant rating of UL94V-2
- Operating temperature should not exceed 75°C (167° F)
- With both insulation and power line protection functions
- Press the lock with finger to set it in the mounting hole of machine board
- Applicable for power supply unit, control box or general power line outlet holes

Type	Model	Outside diameter (machine plate caliber) D(mm)	H(mm)	Head Diameter B(mm)	Thread I.D. A(mm)
Buckles type line protective cover	312-3	8	8.3	9.6	5.2
	375-4	9.5	10.3	12	6.4
	0811	11.1		13.6	8.2
	0813	13		15.1	9.8
	1216	16		18.1	12.9

Tel-
0086-577-62780116

Fax-
0086-577-62774090

Email-
info@etek-china.com

No. 288 Wei 17th Road,
Economic Development Zone,
Yueqing City Zhejiang China.

ETEK[®]
ETEK ELECTRIC

ZHEJIANG ETEK
ELECTRICAL TECHNOLOGY CO.,LTD.

